

# Medallion Pools Inground Liner Order Form

Phone: 1-804-526-7665

sales@medallionpools.com

Fax: 1-804-526-1200

## Basic Information

**Liner Wall Pattern Selected:** \_\_\_\_\_

**Liner Bottom Pattern Selected:** \_\_\_\_\_

**Liner Thickness Selected (circle):** 20mil / 27mil / 27/20 / 20/27 / 28mil / 28/20 / 20/28

**Is there a safety ledge? (circle, if yes give size):** No / Yes \_\_\_\_\_

**Does the pool have any liner covered stairs, benches, loungers, etc.?:** No / Yes

If yes, please complete the appropriate addendum/s to the liner order for your liner covered accessory type.

### Circle Bead Type

A-Bead    J-Bead    Overlap



### Corner Type for Rectangle, True L, or Lazy L

Circle the corner type and fill in the information.

Square

Radius

Diagonal

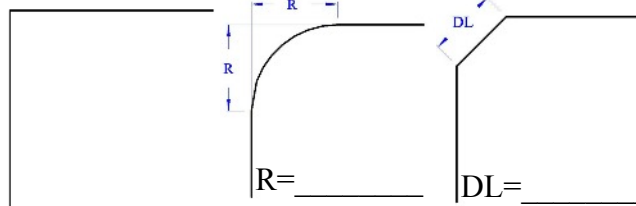

### Cove

Is there a cove around the bottom? No / Yes

If Yes enter values.

S= \_\_\_\_\_

T= \_\_\_\_\_

U= \_\_\_\_\_

S+T must equal

A on page 3

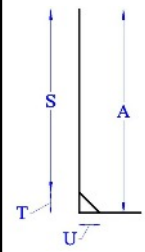

**Draw the pool here and add any necessary information. Give the locations of all stairs even if they are not liner stairs.**

Initial: \_\_\_\_\_

MIGLOF20190528

Page 1 of 4

## Pool Shape

Circle the pool shape that most represents the pool. Measure the dimensions listed and record them in the spaces provided. If your shape is not here, draw it to the best of your ability on page 1 and contact a Medallion representative for further assistance.

### Rectangle

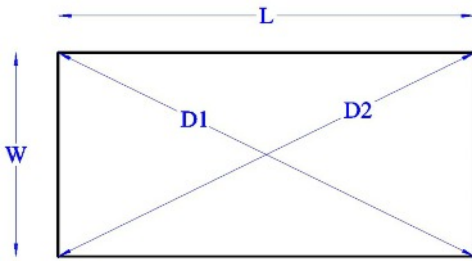

L: \_\_\_\_\_  
 W: \_\_\_\_\_  
 D1: \_\_\_\_\_  
 D2: \_\_\_\_\_

### Oval

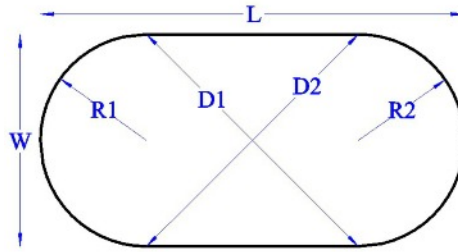

L: \_\_\_\_\_  
 W: \_\_\_\_\_  
 R1: \_\_\_\_\_  
 R2: \_\_\_\_\_  
 D1: \_\_\_\_\_  
 D2: \_\_\_\_\_

### True L Left

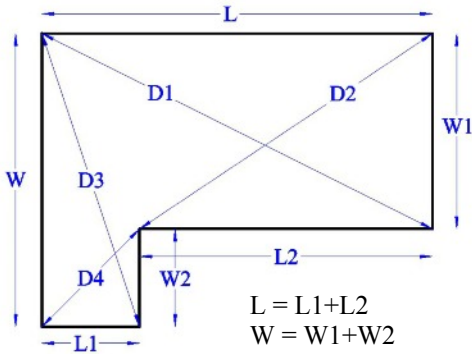

L: \_\_\_\_\_  
 L1: \_\_\_\_\_  
 L2: \_\_\_\_\_  
 W: \_\_\_\_\_  
 W1: \_\_\_\_\_  
 W2: \_\_\_\_\_  
 D1: \_\_\_\_\_  
 D2: \_\_\_\_\_  
 D3: \_\_\_\_\_  
 D4: \_\_\_\_\_

$L = L1 + L2$   
 $W = W1 + W2$

### True L Right

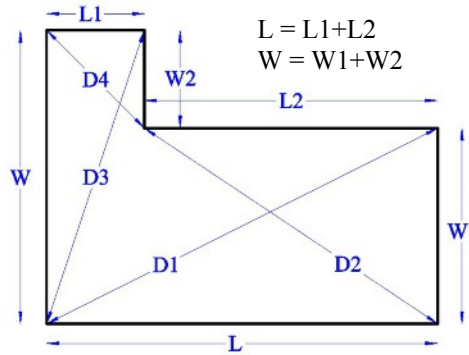

L: \_\_\_\_\_  
 L1: \_\_\_\_\_  
 L2: \_\_\_\_\_  
 W: \_\_\_\_\_  
 W1: \_\_\_\_\_  
 W2: \_\_\_\_\_  
 D1: \_\_\_\_\_  
 D2: \_\_\_\_\_  
 D3: \_\_\_\_\_  
 D4: \_\_\_\_\_

$L = L1 + L2$   
 $W = W1 + W2$

### Lazy L Left

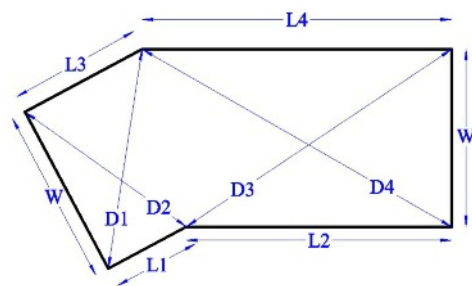

L: \_\_\_\_\_  
 L1: \_\_\_\_\_  
 L2: \_\_\_\_\_  
 L3: \_\_\_\_\_  
 L4: \_\_\_\_\_  
 W: \_\_\_\_\_  
 D1: \_\_\_\_\_  
 D2: \_\_\_\_\_  
 D3: \_\_\_\_\_  
 D4: \_\_\_\_\_

### Lazy L Right

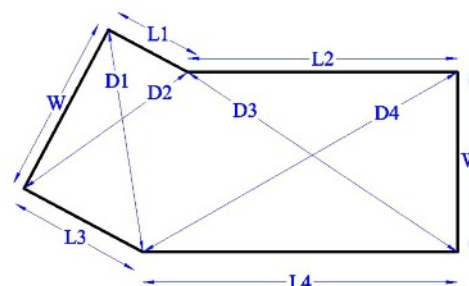

L: \_\_\_\_\_  
 L1: \_\_\_\_\_  
 L2: \_\_\_\_\_  
 L3: \_\_\_\_\_  
 L4: \_\_\_\_\_  
 W: \_\_\_\_\_  
 D1: \_\_\_\_\_  
 D2: \_\_\_\_\_  
 D3: \_\_\_\_\_  
 D4: \_\_\_\_\_

### Grecian

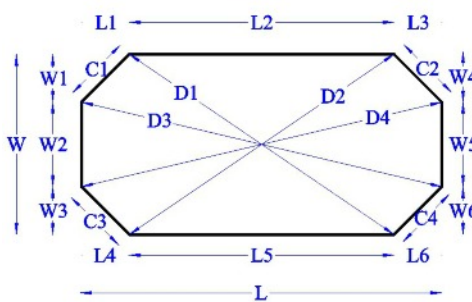

$L = L1 + L2 + L3 = L4 + L5 + L6$   
 $W = W1 + W2 + W3 = W4 + W5 + W6$

L: \_\_\_\_\_ W: \_\_\_\_\_  
 L1: \_\_\_\_\_ W1: \_\_\_\_\_  
 L2: \_\_\_\_\_ W2: \_\_\_\_\_  
 L3: \_\_\_\_\_ W3: \_\_\_\_\_  
 L4: \_\_\_\_\_ W4: \_\_\_\_\_  
 L5: \_\_\_\_\_ W5: \_\_\_\_\_  
 L6: \_\_\_\_\_ W6: \_\_\_\_\_  
 D1: \_\_\_\_\_ C1: \_\_\_\_\_  
 D2: \_\_\_\_\_ C2: \_\_\_\_\_  
 D3: \_\_\_\_\_ C3: \_\_\_\_\_  
 D4: \_\_\_\_\_ C4: \_\_\_\_\_

### Round

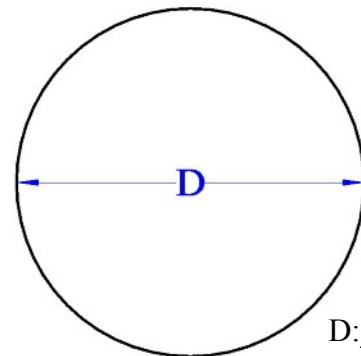

D: \_\_\_\_\_



## **Policies and Agreements**

- In this agreement the terms "Medallion", "us", and/or "we" shall represent Medallion Swim Pool Co., Inc. and any employees of this company. In this agreement the terms "Customer", "you", "your", and/or "Purchaser" shall represent the same as the customer listed at the end of this agreement.
- Medallion does not and will not guarantee the installation or workmanship of any independent contractor or dealer, even if recommended by Medallion. Medallion does not and will not guarantee that anyone recommended by Medallion is licensed or insured. It is the Purchaser's responsibility to perform all due diligence before hiring any contractor, even those recommended by Medallion. This due diligence includes, but is not limited to, checking references, verifying any licenses, verifying current insurance status, checking quality of work, etc. All agreements for installation or service are strictly between you and the independent contractor or dealer and are not any responsibility of Medallion. Any disagreements between you and any independent contractor or dealer are strictly between you and that independent contractor or dealer and in no way involve Medallion. Disagreements between you and the independent contractor or dealer in no way constitute a valid reason to void your contract with Medallion. Regardless of what transpires between you and the independent contractor or dealer all written terms and conditions between you and Medallion will remain in effect.
- All material warranties are per the individual manufacturer's warranty. All warranties are limited in nature. All warranty claims are to be handled directly between the purchaser and the manufacturer of the defective product. See warranty for complete details.
- There are no warranties which extend beyond the description on the face hereof.
- Medallion makes no warranty, expressed or implied, including the warranty of merchantability or fitness for a particular purpose.
- It is mutually understood and agreed that this agreement shall be governed by the laws of the Commonwealth of Virginia, both as to interpretation and performance. Any action at laws, suit in equity, or judicial proceeding for the enforcement of this agreement or any other provision or for any other reason shall be instituted only in the courts of the Commonwealth of Virginia, City of Colonial Heights. Purchaser agrees to be responsible for any and all legal costs for both purchaser and Medallion.
- If you are paying for your purchase with a credit card you also agree to the following: You agree to pay your credit card in accordance with your card holder agreement. You understand and agree that you can not file a chargeback for any reason other than if there is a fraudulent transaction you did not make. By agreeing to buy products from Medallion you understand and agree that you are waiving your rights to a chargeback against Medallion.
- In the event Medallion takes any action against purchaser to collect any monies due Medallion from purchaser hereunder, purchaser agrees to pay all costs of collection including, but not limited to, any attorney's fees.
- It is the purchaser's responsibility to verify that the installation and equipment meet their local, state, and county codes. Any equipment or design changes required will be at the purchaser's expense.
- The purchaser gives Medallion, its successors or assigns, and/or anyone acting under their authority or permission thereof, the unqualified right to make and or copyright the photographs of the homeowners pool and/or spa and all surrounding landscaping and property to use or distribute such photographs or any reproduction thereof, or name, or endorsement, together or separately, anywhere, in any manner, at any time hereafter and as often as desired, for any commercial, public, or private purpose. The purchaser hereby waives all rights of inspection or approval and irrevocably releases Medallion, its successors or assigns, and/or anyone acting under their authority or permission thereof from all claims or demands for the use and publication of such photographs, signature, or endorsement as herein authorized.
- Please note that all liners must be paid in full and all measurements turned in to Medallion before the liner is ordered. Once ordered your liner will normally ship within 5-7 business days. Your liner will be manufactured as per the information you provided above. Once ordered, liners are non-returnable. Returns or exchanges will not be allowed.
- You understand and agree that the liner you are ordering will be manufactured according to the measurements provided on this form. Should the liner not fit due to improper information it is solely your responsibility and not Medallion's.

**Do not sign this agreement until you have read and understood all of the above statements. By your signature below you are stating that you understand and agree to all of the above items. You are also stating that you understand and agree that you are giving up certain legal rights as well as rights with your credit card company.**

I have received, read, understand, and agree to all of the above policies.

Print Name: \_\_\_\_\_

Signature: \_\_\_\_\_ Date \_\_\_\_\_

Address: \_\_\_\_\_

Phone Number: \_\_\_\_\_ E-mail Address: \_\_\_\_\_

# Medallion Pools Liner Order Form Addendum For Corner Stair With Three Treads

Phone: 1-804-526-7665

sales@medallionpools.com

Fax: 1-804-526-1200

## Measurements

R1: \_\_\_\_\_ T1: \_\_\_\_\_

R2: \_\_\_\_\_ T2: \_\_\_\_\_

R3: \_\_\_\_\_ T3: \_\_\_\_\_

R4: \_\_\_\_\_

Finished Pool Depth: \_\_\_\_\_

TL1: \_\_\_\_\_

TL2: \_\_\_\_\_

TL3: \_\_\_\_\_

Step Attachment (circle): Rod Pockets / Bead Track

Notes:

- R1+R2+R3+R4 must equal Finished Pool Depth and must be the same as the finished depth you listed on the the main liner order form.
- T1 must be measured to the true corner as if the corner of the pool was square, regardless of the actual corner type.
- If you have any questions regarding how to fill out this form or how to take these measurements please give your Medallion representative a call.

## Centerline Riser and Tread Measurements

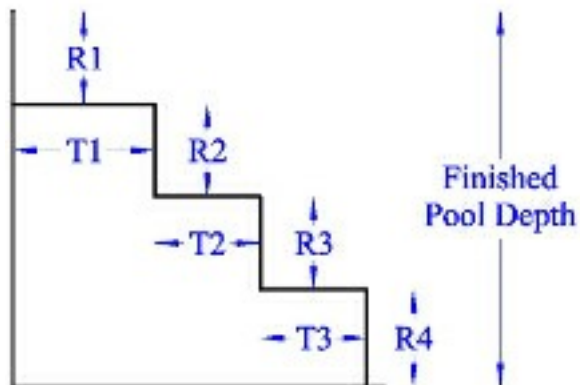

## Tread Length Measurements

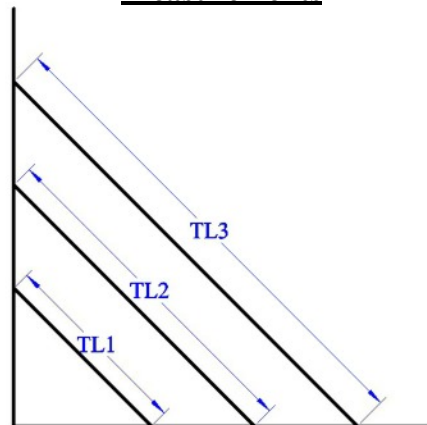

## Corner Shape

Circle the corner type and fill in the information.

Square

Radius

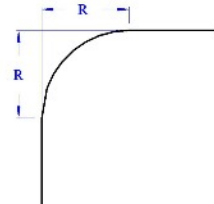

Diagonal

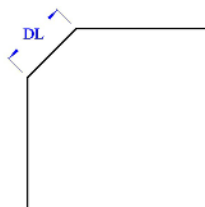

For Radius

R= \_\_\_\_\_

For Diagonal

DL= \_\_\_\_\_

I understand that this is an addendum to the main liner order form and all prior agreements apply to this form.

Signature \_\_\_\_\_

Date \_\_\_\_\_

Printed Name \_\_\_\_\_

# Medallion Pools Liner Order Form Addendum For Corner Stair With Four Treads

Phone: 1-804-526-7665

sales@medallionpools.com

Fax: 1-804-526-1200

## Measurements

R1: \_\_\_\_\_ T1: \_\_\_\_\_

R2: \_\_\_\_\_ T2: \_\_\_\_\_

R3: \_\_\_\_\_ T3: \_\_\_\_\_

R4: \_\_\_\_\_ T4: \_\_\_\_\_

R5: \_\_\_\_\_

Finished Pool Depth: \_\_\_\_\_

TL1: \_\_\_\_\_

TL2: \_\_\_\_\_

TL3: \_\_\_\_\_

TL4: \_\_\_\_\_

Step Attachment (circle): Rod Pockets / Bead Track

Notes:

- R1+R2+R3+R4+R5 must equal Finished Pool Depth and must be the same as the finished depth you listed on the the main liner order form.
- T1 must be measured to the true corner as if the corner of the pool was square, regardless of the actual corner type.
- If you have any questions regarding how to fill out this form or how to take these measurements please give your Medallion representative a call.

## Centerline Riser and Tread Measurements

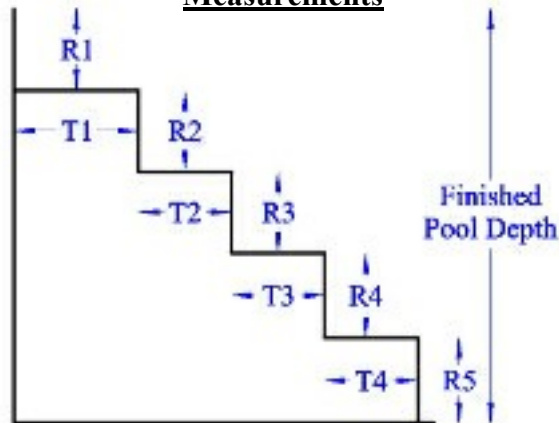

## Tread Length Measurements

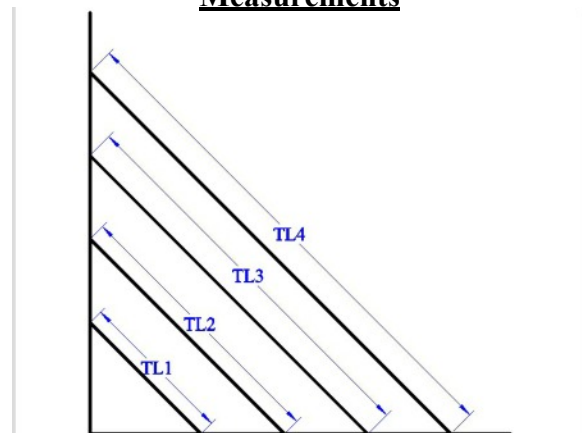

## Corner Shape

Circle the corner type and fill in the information.

Square

Radius

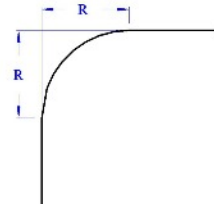

Diagonal

For Radius

R= \_\_\_\_\_

For Diagonal

DL= \_\_\_\_\_

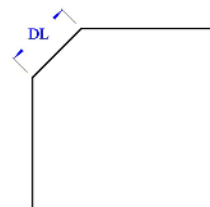

I understand that this is an addendum to the main liner order form and all prior agreements apply to this form.

Signature \_\_\_\_\_ Date \_\_\_\_\_

Printed Name \_\_\_\_\_

# Medallion Pools Liner Order Form Addendum For Recessed Stair With Three Treads

Phone: 1-804-526-7665

sales@medallionpools.com

Fax: 1-804-526-1200

## Measurements

R1: \_\_\_\_\_ T1: \_\_\_\_\_

R2: \_\_\_\_\_ T2: \_\_\_\_\_

R3: \_\_\_\_\_ T3: \_\_\_\_\_

R4: \_\_\_\_\_

Finished Pool Depth: \_\_\_\_\_

A: \_\_\_\_\_

B: \_\_\_\_\_

Step Attachment (circle): Rod Pockets / Bead Track

Notes:

- R1+R2+R3+R4 must equal Finished Pool Depth and must be the same as the finished depth you listed on the the main liner order form.
- T1+T2+T3 must equal B
- If you have any questions regarding how to fill out this form or how to take these measurements please give your Medallion representative a call.

## Riser and Tread Measurements

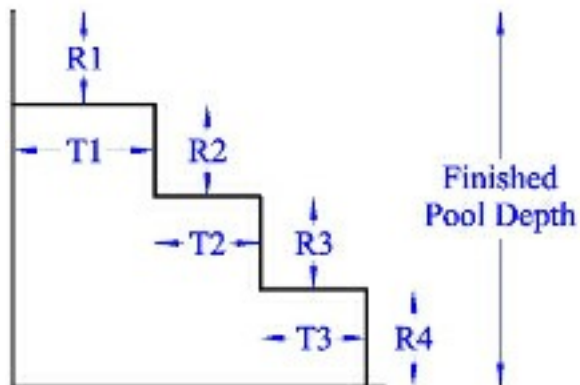

## Stair Overall Measurements

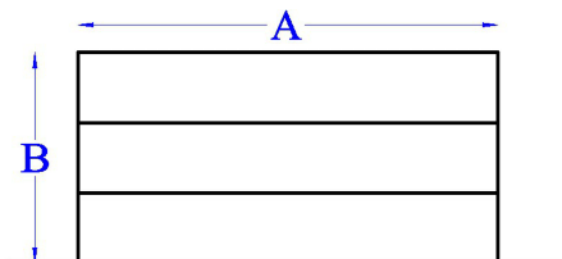

## Front Corner Type

Circle the front corner type and fill in the information.

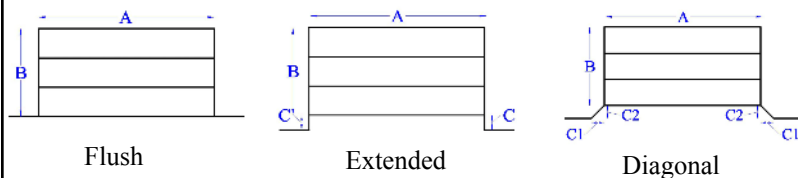

Flush

Extended

Diagonal

Flush: No Additional Measurements Necessary

Extended: C: \_\_\_\_\_

Diagonal: C1: \_\_\_\_\_ C2: \_\_\_\_\_

## Back Corner Shape

Circle the corner type and fill in the information.

Square

Radius

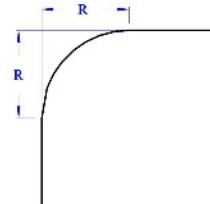

Diagonal

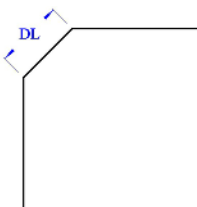

For Radius

R= \_\_\_\_\_

For Diagonal

DL= \_\_\_\_\_

I understand that this is an addendum to the main liner order form and all prior agreements apply to this form.

Signature \_\_\_\_\_ Date \_\_\_\_\_

Printed Name \_\_\_\_\_

# Medallion Pools Liner Order Form Addendum For Recessed Stair With Four Treads

Phone: 1-804-526-7665

sales@medallionpools.com

Fax: 1-804-526-1200

## Measurements

R1: \_\_\_\_\_ T1: \_\_\_\_\_

R2: \_\_\_\_\_ T2: \_\_\_\_\_

R3: \_\_\_\_\_ T3: \_\_\_\_\_

R4: \_\_\_\_\_ T4: \_\_\_\_\_

R5: \_\_\_\_\_

Finished Pool Depth: \_\_\_\_\_

A: \_\_\_\_\_

B: \_\_\_\_\_

Step Attachment (circle): Rod Pockets / Bead Track

Notes:

- R1+R2+R3+R4+R5 must equal Finished Pool Depth and must be the same as the finished depth you listed on the the main liner order form.
- T1+T2+T3+T4 must equal B
- If you have any questions regarding how to fill out this form or how to take these measurements please give your Medallion representative a call.

## Riser and Tread Measurements

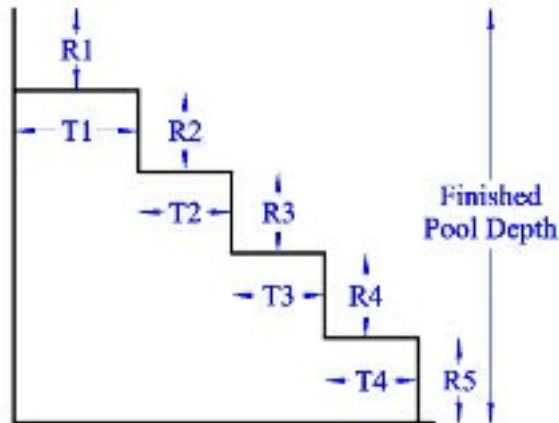

## Stair Overall Measurements

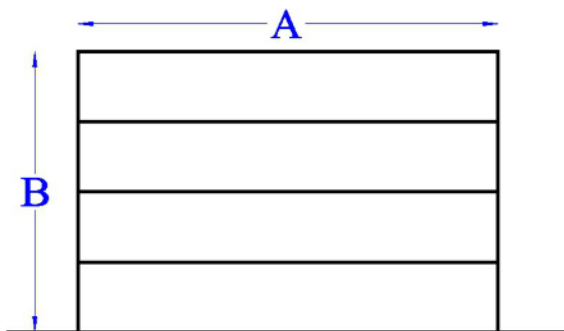

## Front Corner Type

Circle the front corner type and fill in the information.

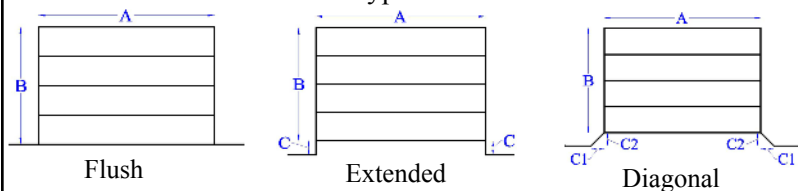

Flush

Extended

Diagonal

Flush: No Additional Measurements Necessary

Extended: C: \_\_\_\_\_

Diagonal: C1: \_\_\_\_\_ C2: \_\_\_\_\_

## Back Corner Shape

Circle the corner type and fill in the information.

Square

Radius

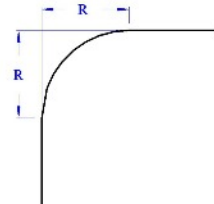

Diagonal

For Radius

R= \_\_\_\_\_

For Diagonal

DL= \_\_\_\_\_

I understand that this is an addendum to the main liner order form and all prior agreements apply to this form.

Signature \_\_\_\_\_ Date \_\_\_\_\_

Printed Name \_\_\_\_\_